

NATIONAL INSULATOR ASSOCIATION



DRIP POINTS

Volume 13

Number 2

Winter 85



NATIONAL INSULATOR ASSOCIATION
6980 WALNUT LK RD
WEST BLOOMFIELD MI 48033

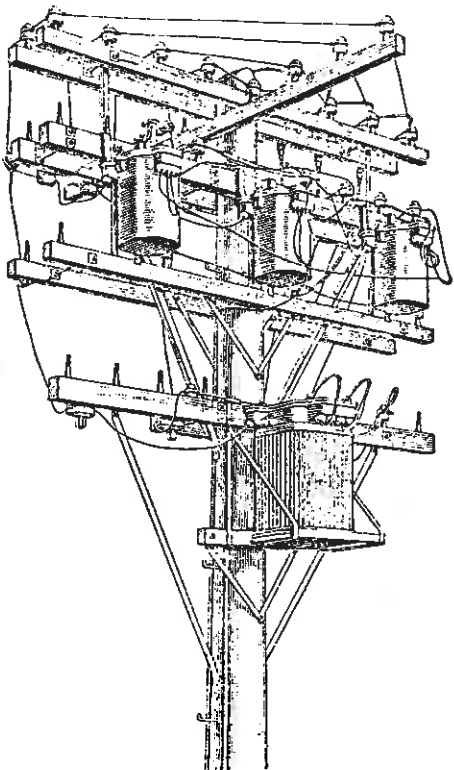

TO:

12-2-85

TOD, JACK
NIA# 13
3427 NORTH 47th PLACE
PHOENIX

AZ 85018

PRESIDENT

Michael Bruner NIA #1482
6980 Walnut Lake Road
West Bloomfield, MI 48033
(313) 661-2359

TREASURER

Rod Krupka NIA #1308
2615 Echo Lane
Ortonville, MI 48462
(313) 627-6351

INFORMATION DIRECTOR

Kenneth Stefan NIA #2413
2240 West Nichols; Apt. E
Arlington Heights, IL 60004
(312) 392-7185

EXECUTIVE DIRECTOR

Kevin Lawless NIA #1679
41 Crestwood Drive
Schenectady, NY 12306
(518) 355-5688

EASTERN REGION VICE-PRESIDENT

John DeSousa NIA #419
5 Brownstone Road
East Granby, CT 06026
(203) 658-0353

CENTRAL REGION VICE-PRESIDENT

Dennis Weber NIA #1889
3609 Jackson
St. Joseph, MO 64507
(816) 364-1312

WESTERN REGION VICE-PRESIDENT

Violet Brown NIA #652
7049 243rd Avenue, NE
Redmond, WA 98052
(206) 885-4862

DRIP POINTS

PUBLISHED QUARTERLY BY

National Insulator Association



COPYRIGHT © 1985 by

NATIONAL INSULATOR ASSOCIATION

All rights reserved

FROM THE PRESIDENT:

Dear NIA Members:

Well, Winter is upon us, but that's ok - we can now concentrate on our indoor hobbies - like collecting insulators.

I've been to some recent shows, and was happy to meet up with old friends. The London, Ohio show was great-as usual, with the War n's, from Alaska, setting up. Nice to see them both.

In regards to the NIA logo change, we are going to give it one more shot - we inadvertently left out the ballots in the last DRIP POINTS issue. Sorry for the inconvenience. You will find the ballot in this issue. This is only a "straw" poll to get your reaction about a possible logo change. Most every company will make a logo change occasionally, and from the response I received from some of you members since the last DRIP POINTS, we might be in for a new logo. Please! - Don't just sit there. Write your thoughts down and mail them to me. My address is on the inside front cover.

It is time again to consider the nomination and election of NIA officers. Up for election in 1986 are two important positions: NIA President and Eastern Region Vice-President. If you have any interest in running for any NIA elected office, or even an appointed position, please drop a line to Russ Hughes, our NIA Nomination Committee Chairman. His address is on the inside back cover.

I hope this is a joyous Holiday Season for all of you and may 1986 be your most rewarding

year ever!

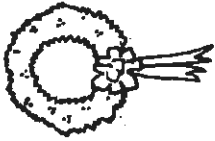

My best!

Michael Bruner

NIA #1482

FROM THE TREASURER:

Renewals have been trickling in, but I have been amazed by the number of new memberships. Twenty-two new members in the past month and half is quite a surprise, especially at this time of year. Credit should be given to four individuals who are greatly responsible. They are Len and Jackie Linscott, Evelyn Milholland, and Jim Crandall.

Len, Jackie and Evelyn have consistently, over time, been the source of new memberships. Our organization owes them a lot. Jim's recent newspaper fame was described in a recent "Crown Jewels" editorial. His press contact has had positive results, I can testify to that.

There has been a recent event which has benefitted the NIA. Mike Guthrie, Dee Willett and the Bakersfield gang have donated \$100.00 from their show receipts to our treasury, and they waived reimbursement toward their advertising. In talking with Mike, he simply said that they felt it was the show host's responsibility to support

FROM THE EXECUTIVE DIRECTOR:

Dear Friends,

Things have been moving rapidly this year. The Eastern Regional Show was held as scheduled, despite a little rain (Hurricane Gloria), which kept quite a few of our fellow collectors away! The Western Regional was a big success, and I had a super time at both of these shows. Also, there was a local show held by the Capital District Insulator Club, which had a very good turnout and brisk sales, and the London, Ohio show was also a fine show. All in all, things are picking up in the insulator collecting hobby!

I would remiss in pointing out that NOW is the time for all of you prospective show hosts to get your information together for the 1987 NIA shows. 1986's shows, of course, are already in the works, with the Western Regional in Enumclaw, Washington, the Central Regional in Omaha, Nebraska, and the National in Saratoga Springs, New York. The 1987 National is due for the Western Region, and I've heard of a couple of possible bidders, already! The Central Regional and Eastern Regional shows I haven't heard any rumblings about, yet - but the deadline of April 1, 1986 will be upon us shortly, so if you have any questions or want a bid form for one of these shows - please don't hesitate to contact me!

The rest of my report concerns the Saratoga Springs SELDOM SEEN display. You will find more information in Marilyn's contribution, about this display, which Marilyn Albers and Jeff McCurty are coordinating. A contributors information sheet has been included in this issue of DRIP POINTS and I encourage all of you to help out.

the NIA, as the NIA supports them and the hobby. What a super attitude to have.

I see this as a challenge folks. Bakersfield has set the pace, lets see if other clubs can keep up.

Before I close, I have two other items. For those of you who are interested, as of November 1st, 1985, our treasury contained \$814.90. Secondly, the NIA still enjoys the membership of only one local insulator club.

I hope Santa brings a lot of glass goodies to each of you and that the new year brings you peace and prosperity.

Robert H. Kuylen

NIA #1308

FROM THE INFORMATION DIRECTOR:

Not too much to report from this side of the typewriter. Guess I'm just like everyone else, getting ready for the holidays.

I hope everyone has a great Holiday Season. And remember, drinking and handling insulators may be hazardous to your collection.

As always!

Ken Stofa

NIA #2413



This will help make the Saratoga Springs National a SUPER SHOW!

Finally, as always, have a safe and happy Holiday Season. Support your local show!



Good Collecting,

NIA #1679

FROM THE CENTRAL REGION VICE-PRESIDENT:

Well, the holiday season is upon us again and the show activity has nearly come to a close for the year, with a long winter lull before things start rolling again in the Spring.

I want to remind everyone that now is the very near future is the time to make those motel reservations for the Central Regional Show at Omaha, May 10 and 11. The AK-SAR-BEN Raceway will open April 30, and as anyone who has been in Omaha during horse racing season can tell you, motel rooms are at a premium during this period, especially since the show site is within a stones throw of the race track. In the past, the Omaha shows have been earlier, before racing season started. So anyone who is even thinking about attending the Regional, please get your reservations early. Remember, in case of a change of plans, it is much easier to cancel reservations than to make them after all the motels are booked up. I can guarantee you that I will have a room reserved well in advance. Anyone needing inform-

ation about the show or a list of possible motels please contact Paul Ickes in Council Bluffs, IA, or contact me and I will see that you get it.

Also, I want to take this opportunity to congratulate John and Carol McDougald for the fantastic job they have done with "Crown Jewels". As I'm sure Dora Harned would tell you, publishing a magazine is no easy task. Dora did a great job for nearly 17 years and now the McDougalds are doing an equally fine job. We all thank you.

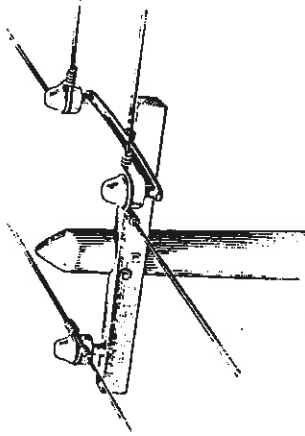

Have a happy Holiday Season,

NIA #1889

FROM THE EASTERN REGION VICE-PRESIDENT:

Our Fall season started off with Hurricane Gloria and the Eastern Regional in Kulpsville, Pennsylvania. The Eastern shoreline and New England was hit hard by Gloria, but it didn't stop the show. With trees down and power out for days, only several of us got out of New England to attend, but it was surely worth it. Alaska, Illinois, Michigan and Ohio were in attendance from the Central and Western regions and we thank them for their support.

The Yankee Bottle Show (New England's Largest) in Keene, New Hampshire and the Capital District Insulator Club's show were also well

attended. Talk of the shows was the 17th National Show that will be in Saratoga Springs, New York. Already the excitement is sparking!

The 17th National will be the best show the hobby has ever experienced. Your hosts are working very hard on every detail to bring this true. I have already received letters for info and tables to be reserved. Be sure to read updates as they appear in DRIP POINTS, "Crown Jewels", "Crown Points", and "Antique Bottle and Glass Collector".

November brought us the 8th Annual Central Florida Insulator Club's show at the Miracle City Mall in Titusville. I was unable to attend, but the reports I have received were outstanding, well supported and some real goodies changed hands.

Happy Holidays

John

NIA #419

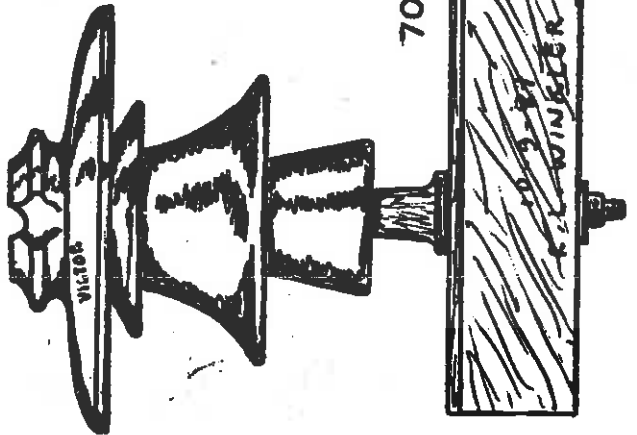

(Detach Inserts)

CONTRIBUTOR INFORMATION - SARATOGA SPRINGS SELDOM SEEN DISPLAY

NAME _____ PHONE _____

ADDRESS _____

CITY _____ STATE _____ ZIP _____

1.) INSULATOR NAME _____ CD/U # _____

MARKINGS _____ COLOR _____

CONDITION _____ ADDITIONAL INFO _____

2.) INSULATOR NAME _____ CD/U # _____

MARKINGS _____ COLOR _____

CONDITION _____ ADDITIONAL INFO _____

3.) INSULATOR NAME _____ CD/U # _____

MARKINGS _____ COLOR _____

ON CONVENTION, SHOW AND SALE will be held at
522 Broadway, Saratoga Springs, New York, on:

.. - 4 P.M. (NIA members, only)
door. Annual dues are \$8.00)
P.M. (OPEN TO ALL - FREE ADMISSION!)
.M. (OPEN TO ALL - FREE ADMISSION!)
Dealer Unloading/Display Set-Up)
A.M. Dealer & Display Set-Up)

beautiful RAMADA RENAISSANCE HOTEL, 534
(Attached to the City Center!) Special NIA
er lodging will also be available. Campers
nd not miss the action.

ULATORS, BOTTLES, ADVERTISING, TELEPHONE
ROD EQUIPMENT, STONEWARE, JARS, etc....
planned or available including:

een, rare and unusual insulators. Any glass,
s, foreign or American insulator will be
ldom Seen!" Marilyn Myers and Jeff McCarty
ordinating the Display. It will take a lot of
op "Herkimer's Threasure" and "Sacramento's
plays will also be provided. All NIA judging
exhibits.

icipated for Friday, July 11 at the Saratoga
ict with either the show or the NIA General
ll be held at 4:30 P.M. at the Ramada Hotel.
ving plenty of time for dinner, etc.

ated just minutes away in Ballston Spa. All
should visit this tract to glass. Special

t the Ramada Hotel on Saturday, July 12,
eal with room for 25 attendees. The famous
led, of course!

available around 1-15-66 from the SHOW HOSTS:
less, NIA #1679 Doug MacGillivray, NIA #259
ood Drive 51 Avondale Road
dy, NY 12306 Manchester, CT 06040

JEWELS OF THE WIRE", MANIQUA BOTTLE & GLASS
OINTS". SEE YOU IN SARATOGA SPRINGS!

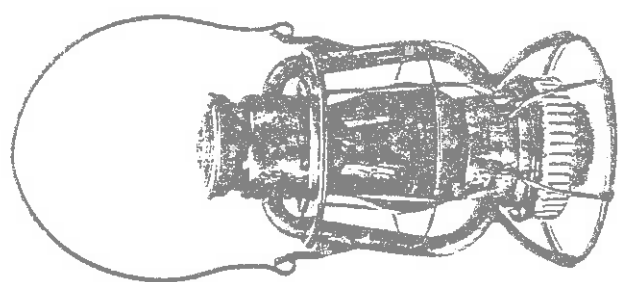
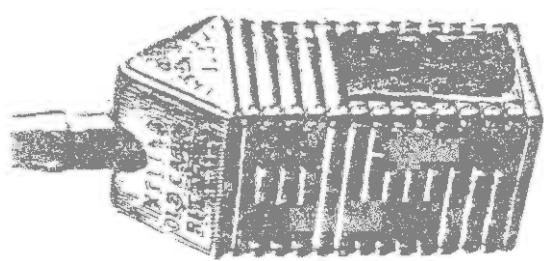
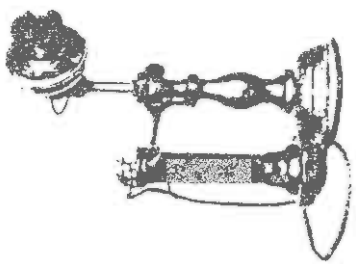
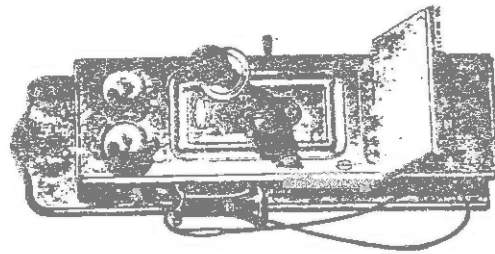
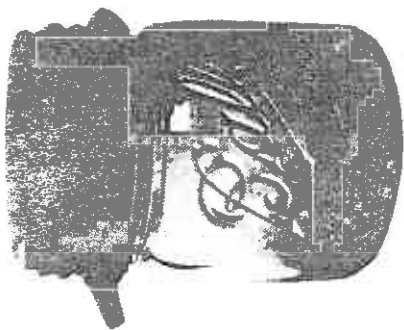

The 17th Annual National Insulator Association Convention and Giant Antique Collectibles Show & Sale

SARATOGA SPRINGS CITY CENTER
522 Broadway, Saratoga Springs, NY

SATURDAY, JULY 12, 1986 -- 9 a.m. - 3 p.m.
SUNDAY, JULY 13, 1986 -- 9 a.m. - 3 p.m.

(FRIDAY, JULY 11, 1986 -- 10 a.m. - 4 p.m. -- NIA Members Only)
FREE ADMISSION -- 200 + TABLES

DEALER DISPLAY INFO -- CONTACT HOSTS:

John deSousa NIA #419
5 Brownstone Rd.
East Granby, CT 06026

Kevin Lawless NIA #1679
41 Crestwood Dr.
Schenectady, NY 12306

Doug Mac Gillivray NIA #259
51 Avondale Rd.
Manchester, CT 06040

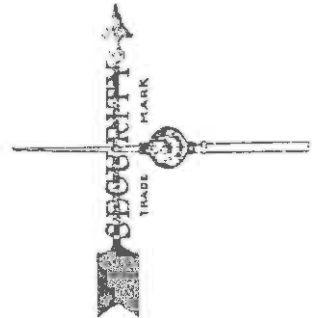

THE 17TH ANNUAL NATIONAL INSULATOR ASSOCIATI

the brand new SARATOGA SPRINGS CITY CENTER,

Friday, July 11, 1986 - 10 A.M.
 (Non-members may join at the
Saturday, July 12, 1986 - 9 A.M. - 3 P.M.
Sunday, July 13, 1986 - 9 A.M. - 3 P.M.
 (July 10, 1986 - 2 P.M. - 6 P.M.
 (July 11, 1986 - 6 A.M. - 10 P.M.)

The convention headquarters will be the Broadway, Saratoga Springs, New York 12866. Convention rates will be arranged, and others will be able to stay at nearby campgrounds as well.

This show will feature 200 tables of INSULATOR ARTIFACTS, RAILROAD COLLECTIBLES, LIGHTNING

- In addition, many other special features are available:
1. A giant display featuring seldom seen porcelain, threaded, threaded, threaded welcome, just as long as it's "See you'll be handling specifics and categories work, but we're going to try to do California"! Space for 25-30 display categories will be acceptable for
 2. An "NIA Night at the Races" is anticipated at the Harness Track. This will not conflict with the General Assembly which will be held at the same time. Post time is around 8:00 P.M., leading to a
 3. The National Bottle Museum is located at the insulator and bottle collectors tour hours may be arranged.
 4. The NIA Banquet will be held at the Saratoga Hotel featuring a delicious sit-down meal. Jerry Turner Awards will be included in the program.

Dealer/Display Information Packets will be available at the convention.

John deSousa, NIA #419 Kevin Law
 5 Brownstone Road 41 Crest
 East Granby, CT 06026 Schenectady

Regular updates may also be seen in "CROWN COLLECTOR" and the NIA's newsletter, "DRIP

4.) INSULATOR NAME _____ CD/U # _____ MARKINGS _____ COLOR _____ ADDITIONAL INFO _____

5.) INSULATOR NAME _____ CD/U # _____ MARKINGS _____ COLOR _____ ADDITIONAL INFO _____

6.) INSULATOR NAME _____ CD/U # _____ MARKINGS _____ COLOR _____ ADDITIONAL INFO _____

FROM THE FIRST-PAST PRESIDENT:

I've had the opportunity to do some traveling this fall, and wanted to share with you a couple of good experiences, both to do with insulators, of course!

While in Washington D.C., my husband and I made it a point to try and find the insulator display that was donated to the Smithsonian by Gerald and Esta Brown. We located it in the American History section of the museum. There were a good number of different CD's represented, from common to rare, and right beside the display was a little plaque with the Brown's name on it. Made ue proud!

Also, spent some time with our good friends, Keith and Jane Neal, on the island of Guernsey. What perfect hosts these two are! While there, I was able to make more drawings of some of Keith's rare British telegraph insulators.

Another special treat was a visit to the Guernsey Telephone Museum. The people there were extremely nice, and of course were already well acquainted with Mr. Neal. They showed me their display of British insulators, and explained that the two small glass insulators off the side had come to them from the States, but they knew nothing about them. One was an aqua CD 106 Hemingray No.9 and the other was a clear CD 115 Whitall Tatam.

When I returned home, I wrote up some information on the Hemingray Glass and Whitall Tatam companies, as well as an explanation of our CD system. I also chose two glass insulators that I thought would further enhance their display...a CD 121 AM TEL & TEL CO in SCA, and

(Detach Inserts)

FROM THE NOMINATION COMMITTEE CHAIRMAN:

At next year's NIA National in Saratoga Springs, New York, Michael Bruner's term of office as President; and, John DeSousa's term as Eastern Region Vice-President will expire. At this time I would like to begin taking recommendations and nominations for the above two positions.

Anyone interested in acquiring further information regarding duties and responsibilities of these two offices can contact me by phone or mail. I will be glad to discuss and/or answer any questions that might arise.

The positions of President and Regional Vice-Presidents are a very important part of the NIA. To insure the continued success of our hobby, I hope to get a good response from you, the NIA membership, in assisting me in selecting good candidates to choose from.

Russ Hughes

NIA #2859

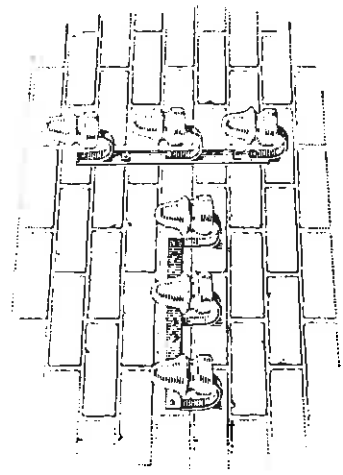

a CD 151 ISOREX/DC-2 in emerald green. I chose the ISOREX because it is from France, and Guernsey is only about 20 miles from the French coast. All this went in a box headed for the Guernsey Telephone Museum as a donation from the NIA! Just inside the lid of the box I put an NIA handbook, which will tell them all about our wonderful organization. I wouldn't be surprised if this became part of their display, too!

Please be sure to read the special flier in this issue of DRIP POINTS, which tells about the BIG general display of SEEDOM SEEN insulators which is planned for our 17th National Convention in Saratoga Springs, New York, July 11-13. Jeff McCurdy and I are coordinating this effort, and we hope to have such a terrific exhibit that it will knock your sox off! But we need your insulators to make it a success. Use the enclosed form and mail it to me. It was a concerned contributor who said we could borrow his insulators if we promised not to assign them crazy new CD numbers or paint them yellow! We promise!

See you then, or sooner.

Marceline Albano

NIA #541

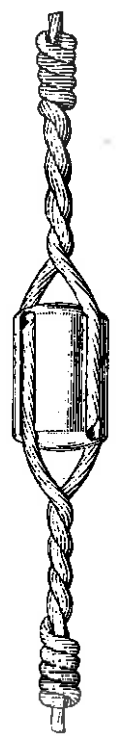

NEW MEMBERS SINCE LAST LISTING
PUBLISHED IN "DRIP POINTS"

- NIA # 3624 Doug Scott
Route 6 - Highland Park
Laurinburg, NC 28352
- NIA # 3625 Jerry Mulrooney
218 SW Essex Drive
Port St, Lucie, FL 33457
- NIA # 3626 Jim Hannah
405 Ashwood Ct.
Schaumburg, IL 60193
- NIA # 3627 David Tesch
Route 2, Box 27
Seymour, WI 54165
- NIA # 3501 Phillip D. Blue
3502 Gracealee Blue
8170 Crow Cutoff So.
Pueblo, CO 81004
- NIA # 3608 Thelma Standaert
558 W. Third Street
New Richmond, WI 54017
- NIA # 3609 Russell Ramsey
35 Empire Blvd.
Brooklyn, NY 11225
- NIA # 3610 Mrs. Neva G. Pratt
5112 Pruitt Drive
Box 93411
The Colony, TX 75056

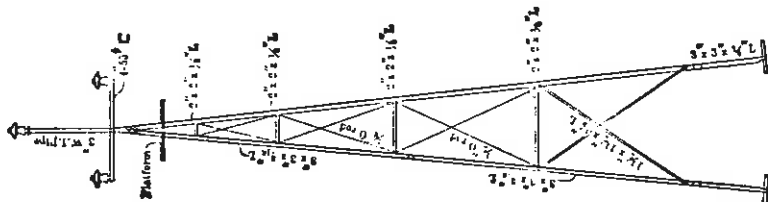

- NIA # 3611 David J. Aldred
1205 Scenic Drive
Southlake, TX 76092
- NIA # 3628 Rose Manley
3629 Francis Manley
Route 5, Box 317
Rye, CO 81069
- NIA # 3630 David E. Wilson
3657 Pegg Avenue
Columbus, OH 43214
- NIA # 3631 J. A. Hare
5645 NE 55th Street
Seattle, WA 98105
- NIA # 3632 Wilda Briggs
P. O. Box 161
Nome, TX 77629
- NIA # 3633 Blanche Jacobs
1708 Caminto Ardiente
La Jolla, CA 92037
- NIA # 3634 Tom Szwaja
3635 Patricia E. Szwaja
P. O. Box 644
West Point, CA 95255
- NIA # 3636 Gerald McDonald
1219 West Grant Street
Appleton, WI 54914
- NIA # 3637 Ronald Dodd
6919 Leameadow Drive
Dallas, TX 75248
- NIA # 3638 Thomas J. Grunau
2586 S. Ouray Way
Aurora, CO 80013

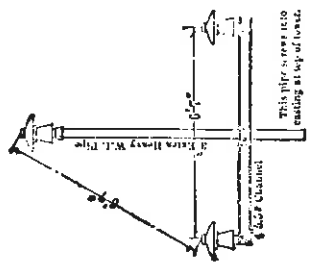

WELCOME TO ALL OF YOU!!



ASSOCIATION TRAVEL

REPORT

New! Introducing InstantAlamo

What's News

InstantAlamo is a faster, personalized way for customers to rent from Alamo using our computer system to store basic information about each renter, to speed reservations and rental service.

Apply for an **InstantAlamo** ID # right at the counter the very next time you rent and enjoy these benefits:

- **Faster reservations** . . . just give your **InstantAlamo** ID #.
- **Faster rental processing** . . . your rental agreement is ready within seconds at the counter. Simply verify the information and you're on your way.
- **Faster returns** . . . (for credit card customers, tear-off your copy of the rental agreement and deposit the rest in our Express Return.
- **Personal preferences** . . . we know what you want. Your preferred credit card and car class preference are also on file (for your convenience).

Fully Equipped Model:	NATIONWIDE		FLORIDA HAWAII WEEKLY SPECIAL
	DAILY	WEEKLY	
Economy Car	\$22	\$99 ⁹⁵	\$79 ⁹⁵
Compact Car	\$24	\$119 ⁹⁵	\$89 ⁹⁵
Midsize Car	\$26	\$139 ⁹⁵	\$99 ⁹⁵
Standard Car	\$28	\$159 ⁹⁵	\$119 ⁹⁵
Midsize Wagon	\$30	\$179 ⁹⁵	\$129 ⁹⁵
Luxury Car	\$32	\$199 ⁹⁵	\$159 ⁹⁵

RATES GUARANTEED JANUARY 1 THROUGH JUNE 30, 1986

Subscribers will apply during each month. Car categories subject to availability. Taxes, insurance, and optional equipment extra. Rental deposit, optional Collision Damage Waiver, and Personal Accident Insurance available. Minimum 5 day minimum for weekly rate.

For Instant Reservations:

- Call Toll Free 1-800-732-3232 • Request "Plan BY"
- You must use your Association ID #

FLORIDA FREE DAY OFFER

- Valid for A Midsize or Larger Car Only
- Must be in conjunction with Association Rates
- Minimum Rental of 3 Days
- Effective December 1-20, January 2-31, 1986

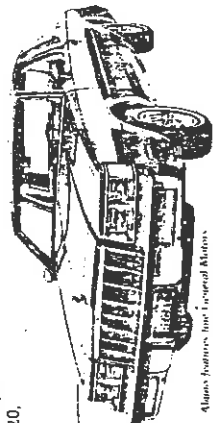

Alamo's features two tropical climates cars such as the bank Regal.



Present this certificate on arrival at the Alamo counter at any Florida location. Reserve 24 hours in advance. Be sure to use your Association ID #, Number and request Plan BY. Call your professional Travel Consultant or Alamo at 800-732-3232.

NIA IDENTIFICATION NUMBER: 93236

PLAN CODE: "BY"

WANTED

FOR SPRING 1986 DRIP POINTS

STORIES, LETTERS, DRAWINGS, SKETCHES, CARTOONS, OR WHATEVER

SEND CONTRIBUTIONS TO:

DRIP POINTS
2740 W. NICHOLS RD. #E
ARLINGTON HTS. IL 60004

---NIA RALLOT---

survey only!

MAIL TO: NIA LOGO CHANGE
6980 WALNUT LAKE ROAD
WEST BLOOMFIELD, MI 48073

QUESTION: SHOULD THE NIA LOGO BE CHANGED?

NO, I THINK THE LOGO IS FINE THE WAY IT IS.

YES, I WOULD LIKE TO SEE THE LOGO CHANGED TO:

- CD-257 Mouse
- CD-162 Signal
- CD-_____ (Write in)
- U-_____ (Write in)

Name: (optional)
(feel free to attach any comments to this survey!)

NATIONAL INSULATOR ASSOCIATION
INFORMATION ON N.I.A. MEMBERSHIP



The Fiscal year for membership dues starts and ends on March 31. The current dues amounts for various membership classes are:

- \$6.00 Adult (Regular individual membership)
- \$6.00 Family (This type of membership is for one voting adult and other family members at the same address. Enclose an additional \$1.00 for each family member who wishes voting privileges.)
- \$1.00 Junior (Under 18 years of age)

Make checks payable to "National Insulator Association" and send to:
 National Insulator Association, c/o Treasurer Rod Krupka,
 2615 Echo Lane, Ortonville, MI 48462 (313-627-6351).

Each member, if not a subscriber to the magazine "Insulators--Crown Jewels of the Wire", will receive a copy of the March issue of that publication which serves as the name-and-address directory of all NIA members. Subject to the availability of March copies, new members may have to await the succeeding March directory issue.

New members are entitled to all membership privileges immediately upon payment of current dues. Regular and Junior members receive all NIA mailings including the quarterly newsletter, membership directory and membership handbook. Family members do not receive duplicates of these mailings to the same address, but do receive the membership card.

A current membership allows a member to display and purchase a sales table at NIA National Conventions and assures admittance to the show on the first day, Friday, which is limited to NIA members only.

I (we) apply for () New Membership () Renewal Membership in the National Insulator Association.

NIA # (If Renewal)

Name _____ # _____

Street _____ Phone _____

City _____ State _____ Zip _____

Family Members: _____ # _____

_____ # _____

_____ # _____

_____ # _____

_____ # _____

Amount Enclosed \$ _____

IMMEDIATE PAST PRESIDENT

Marilyn Albers NIA #541
 14715 Oak Bend Drive
 Houston, TX 77079
 (713) 497-4146

SECOND PAST PRESIDENT

Pat Patocka NIA #140
 P.O. Box 326
 Penryn, CA 95663
 (916) 663-3681

ETHICS CHAIRMAN

John McDougald NIA #689
 26812 John Road
 Olmsted Township, OH 44138
 (216) 235-2595

SHOW STANDARDS CHAIRMAN

Charlie Allmon NIA #2814
 1200 W. 76th Street
 Kansas City, MO 64114
 (816) 333-6727

NOMINATION COMMITTEE CHAIRMAN

Russ Hughes NIA #2859
 2560 South Vrain Street
 Denver, CO 80219
 (303) 922-7733

HISTORIAN

Chris Hedges NIA #15
 P.O. Box 10378
 Kansas City, MO 64111
 (816) 753-0921

AUTHENTICATION COMMITTEE

Ray Klingensmith NIA #1654
 709 Route 232